

RECOVIB

TINY

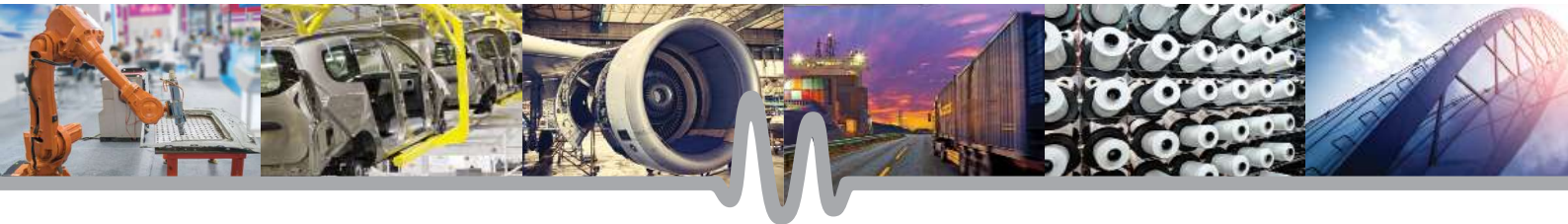

3-AXIS SHOCK & VIBRATION DATA LOGGER

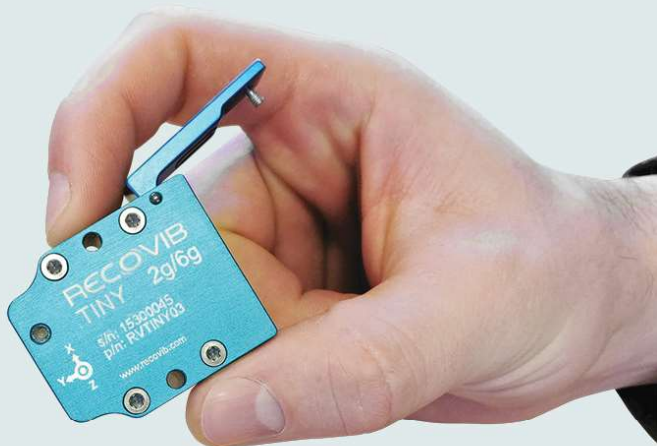

PROPERTIES

- 3 axis
- DC to 250Hz useful bandwidth
- Low noise
- 6-hours battery autonomy (1024 samples/second)
- 2 GB storage capacity
- Wireless during vibration measurements
- Compact and rugged design
- Protection grade IP65 - Total protection against dust & splashing water
- Several sensors can measure synchronously and simultaneously
- Synchronization in millisecond level for several hours

POSSIBLE USE

- “Quick & dirty” vibration monitoring & diagnosis
- Remote vibration diagnostic/consultancy
- Vibration measurement on rotating parts
- Vibration modal analysis
- Machine tools - Automotive - Aviation
- Structural analysis and health monitoring
- Traffic and transport sector



SYNCHRONISATION



STAND ALONE



ROBUST & SOLID



PRECISE



MINIATURE

BENEFITS

Our new wireless vibration recorder, the RECOVIB Tiny measures vibrations and shocks in all three axis. It is extremely practical for a vibration diagnosis, offering up to 6 hours of measurement.

Its wireless technology and intuitive operation provides substantial time savings in the performance of your measurements.

It is the only type of vibration and shock recorder that allows several sensors to be used simultaneously in a synchronized manner enabling the performance of modal analyses and operational deflection shape

analyses on large structures such as bridges or walkways.

We offer different measuring ranges : $\pm 2/6G$, $\pm 15G$, $\pm 200G$. It is able to record 1024 acceleration values (shocks and vibrations) per channel per second.

The RECOVIB Tiny is the smallest, lightest and the most robust recorder on the market that is able to perform recordings in extreme conditions ranging from $-10^{\circ}C$ to $+50^{\circ}C$. It is also dust and water tight to IP65.

BLOCK DIAGRAM

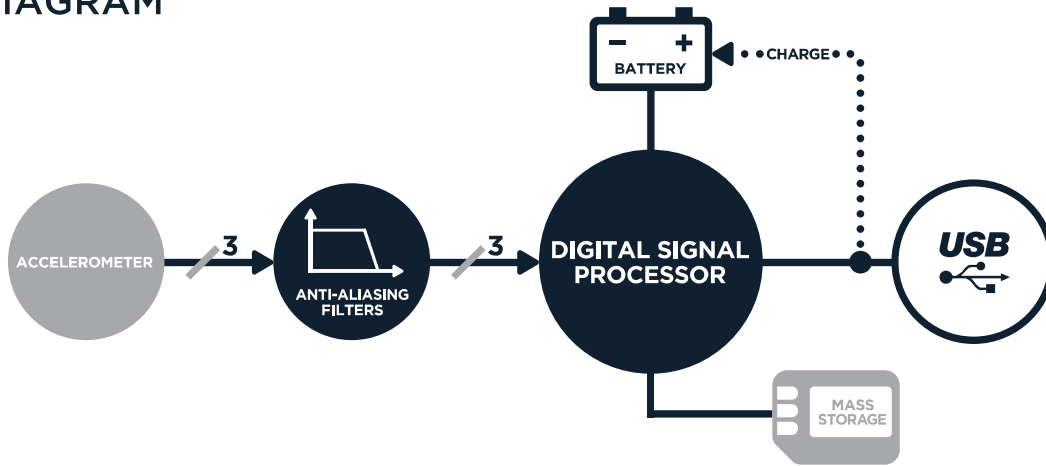

OPERATION

To set up the RECOVIB Tiny, all you have to do is to connect the sensor to a PC or a smartphone via a USB connection. The supplied software allows for time synchronization with the PC, selection of the measuring range, as well as programming of the measurement interval.

When the sensor is disconnected from the PC or the smartphone and when the preset measurement start time is reached, the RECOVIB.Tiny begins to autonomously measure and store vibration values.

Once the preset stop time is reached, the RECOVIB.Tiny goes into sleep mode until it is reconnected to the PC or the smartphone.

The RECOVIB Tiny is therefore recognized by the PC or the smartphone as an external storage device. Thanks to the supplied software, the measurements of one or more sensors stored in a compact binary format can be converted to standard formats depending on user preference (text, CSV, MATLAB™, LabVIEW™ formats).

The Recovib Tiny is supplied with magnets for easy mounting.

When several synchronized sensors are used for a measurement, all the data are stored in one single file with one single time stamp.

CERTIFICATIONS

	STANDARD	STANDARD REFERENCE	LIMIT LEVEL
EMC COMPLIANCE	Radiated Emission	EN 55016-2-3/CISPR 16-2-3	EN/IEC 61000-6-3 30MHZ - 1 GHZ
	Electrostatic Discharge Immunity	EN / IEC 61000-4-2	4 kV by contact 2, 4 & 8kV in air Criterion B
	Magnetic Field Immunity	EN / IEC 61000-4-8	80 A/m 50 & 60 Hz Criterion A
	Radiated, radio-frequency, electromagnetic field immunity	EN/IEC 61000-4-3	80 MHz - 1 GHz 10 V/m 1.4 - 2.0 GHz 3 V/m 2.0 - 2.7 GHz 1 V/m AM 80% 1 KHz Criterion A
DUST & WATER INGRESS PROTECTION LEVEL	Degree of Protection provided by enclosures (IP code)	IEC 60529	IP65

SPECIFICATIONS

	Model	$\pm 2g$ or $\pm 6g$	$\pm 15g$	$\pm 200g$
MEASUREMENT CHARACTERISTICS	Lower frequency limit	0Hz (DC)		
	Passband frequencies (per channel)	250 Hz		
	Storage rates (per channel)	1024 samples per second		
	Output unit	$m/s^2 - g$		
	Non-linearity	$\pm 0,5 \% \text{ F.S.}$	$\pm 0,3 \% \text{ F.S.}$	$\pm 0,5 \% \text{ F.S.}$
	Residual noise density	$30 \mu g/\sqrt{\text{Hz}}$	$300 \mu g/\sqrt{\text{Hz}}$	$2600 \mu g/\sqrt{\text{Hz}}$
	Residual noise (250 Hz bandwidth)	475 μg	4,75 mg	47 mg
	Transverse sensitivity	$\pm 2 \%$	$\pm 2 \%$	$\pm 2 \%$
AUTONOMY	Battery	6 hours		
	Storage	2GB		
OUTPUTS FORMATS	Binary, txt, CSV, NI LabVIEW, MATLAB (Level 5 MAT-file)			
ENVIRONMENTAL CHARACTERISTICS	Operating Temperature range	$-10 .. 50^{\circ}\text{C}$		
	Temperature coefficient of sensitivity	$\pm 0,01 \%/^{\circ}\text{C}$	$\pm 0,01 \%/^{\circ}\text{C}$	$\pm 0,02 \%/^{\circ}\text{C}$
	Temperature drift of zero point	$\pm 0,4 \text{ mg}/^{\circ}\text{C}$	$\pm 1 \text{ mg}/^{\circ}\text{C}$	$\pm 30 \text{ mg}/^{\circ}\text{C}$
	Protection grade	IP65		
MECHANICAL DATA	Weight	33.5gr		
	Case Material	Aluminum		

DIMENSIONS

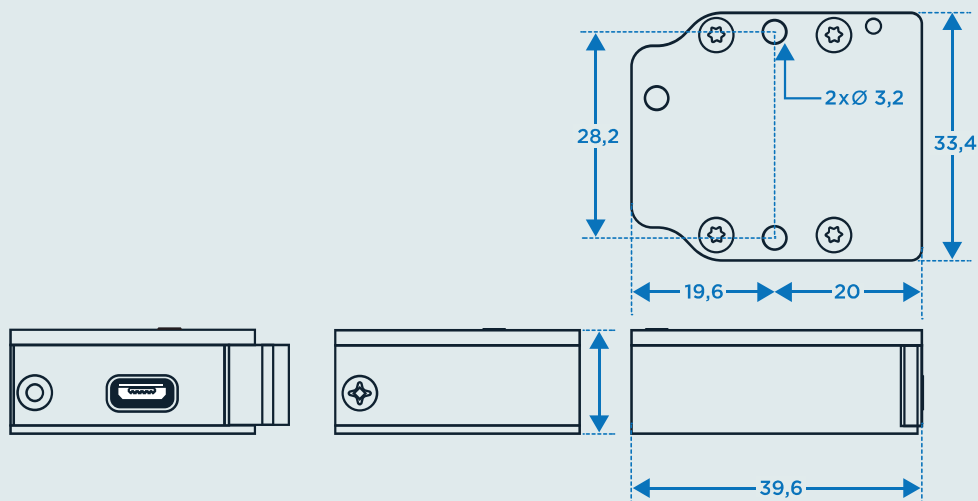

RECOVIB SUITE SOFTWARE

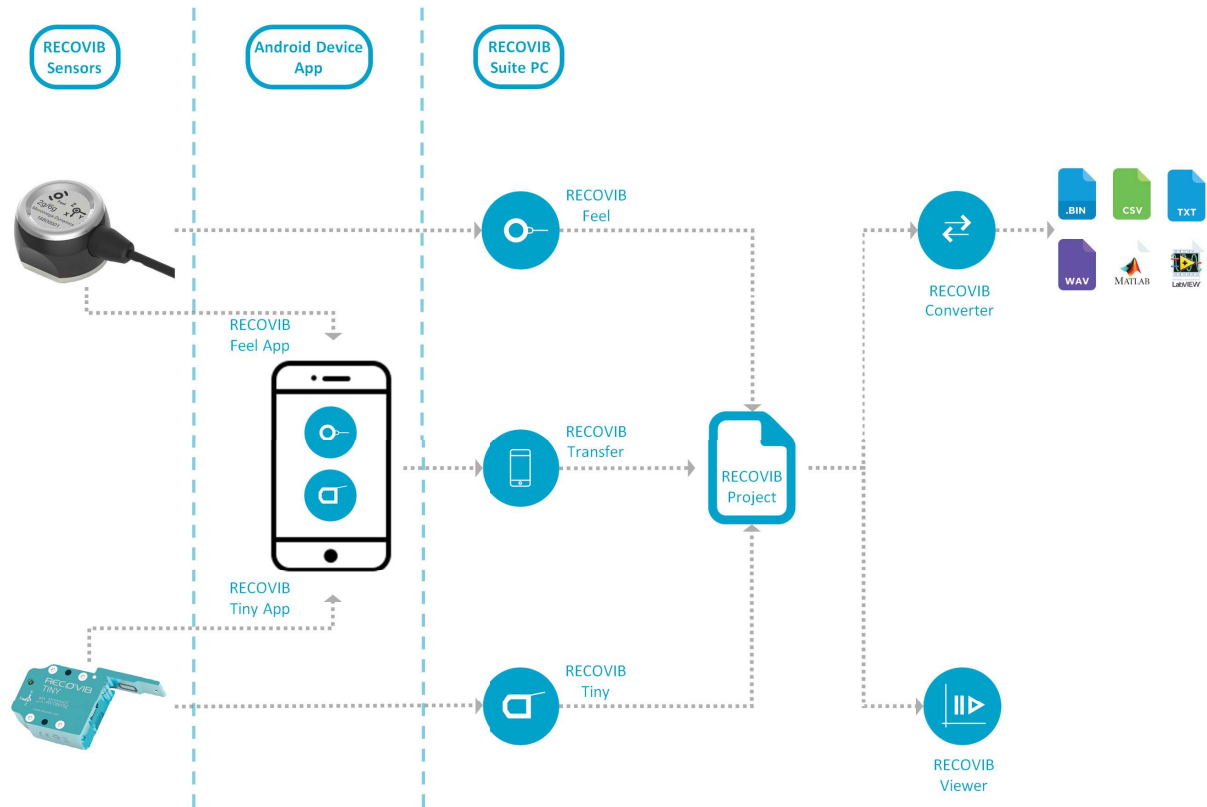

SIGNAL PROCESSING BLOCK DIAGRAM USED IN RECOVIB TINY ANDROID APP. AND RECOVIB VIEWER

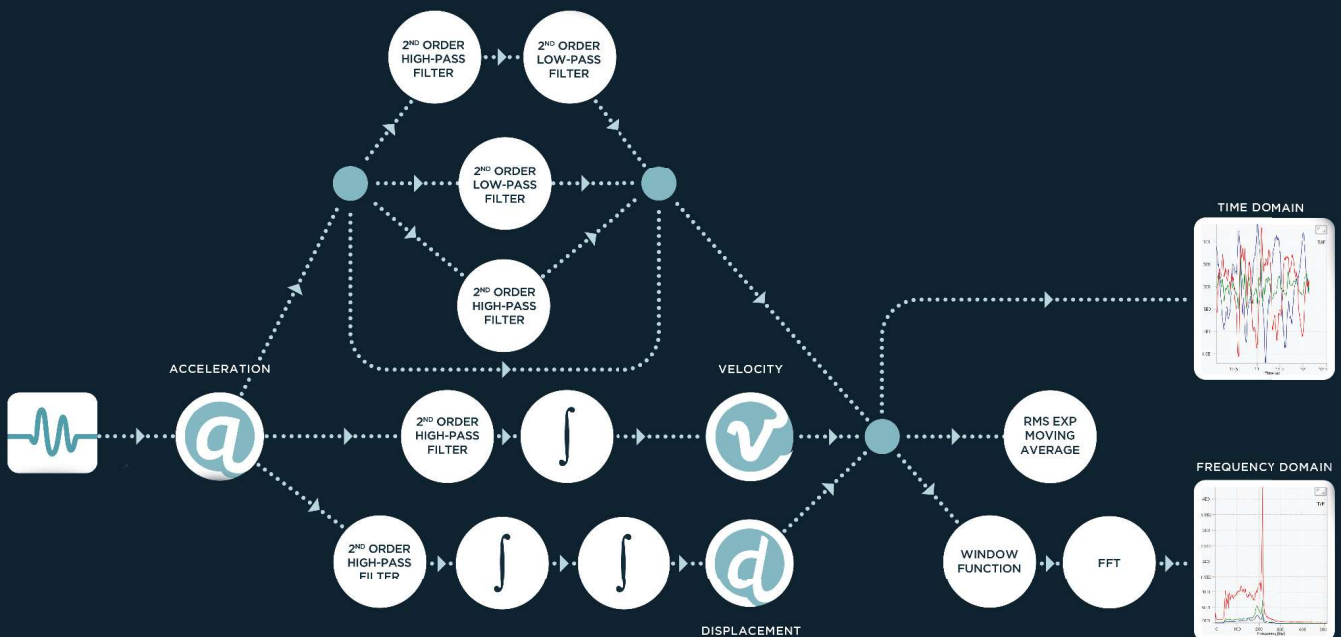

RECOVIB TINY ANDROID APP.

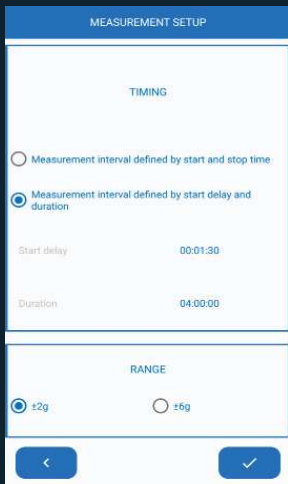

SENSORS SETUP

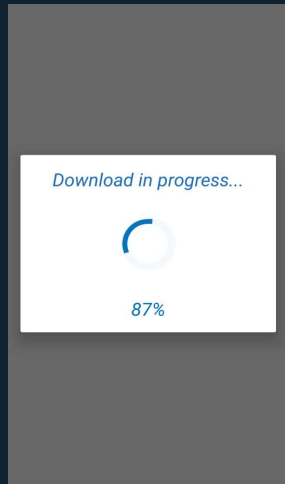

DATA DOWNLOAD

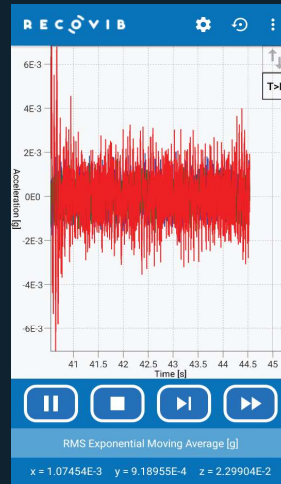

ANALYSIS MODE

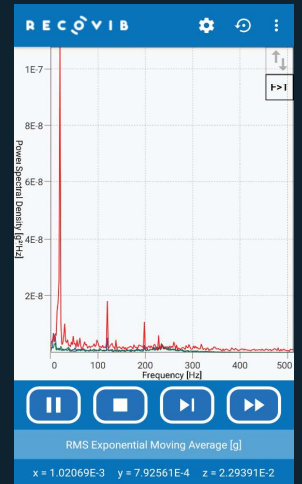

RECOVIB SUITE COMPUTER SOFTWARE

Program your sensors, export and analyze your data thanks to our RECOVIB Suite SOFTWARE which includes 4 tools :

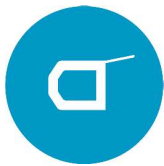

RECOVIB Tiny

- Multi-Sensors setup
- Download device measurements



RECOVIB Transfer

- Transfer the Android RECOVIB Projects from your Android devices to your computer



RECOVIB Converter

- Convert RECOVIB measurements into the format of your choice



RECOVIB Viewer

- Analysis PC Software
- Replay and analyze data taken from RECOVIB Projects in the time and the frequency domain

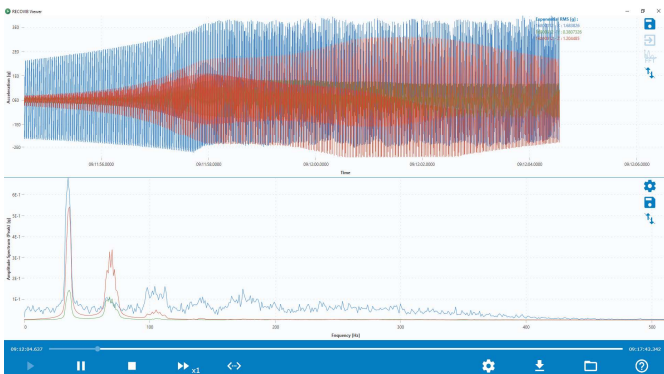

DATA ANALYSIS

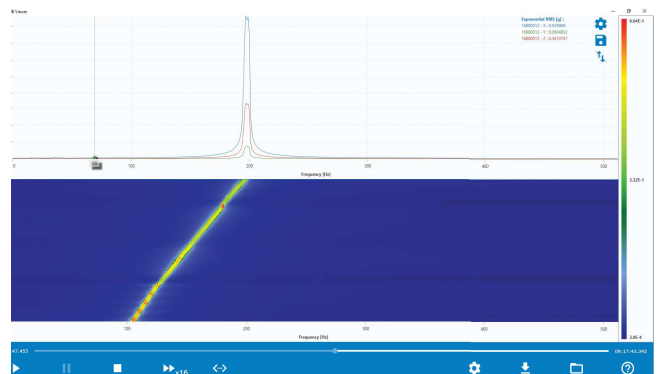

SPECTROGRAM FEATURE

ORDER REFERENCE

SENSORS

RECOVIB-TINY 2G/6G	3-axis logger $\pm 2g$ or $\pm 6g$ range (software selectable)
RECOVIB-TINY 15G	3-axis logger $\pm 15g$ range (fixed)
RECOVIB-TINY 200G	3-axis logger $\pm 200g$ range (fixed)
Each logger comes with 2 pot magnets and a USB cable. It is intended to be stored in a specially designed suitcase.	

ACCESSORIES

TINY-SUITCASE-1-EU	Suitcase for one RECOVIB-TINY Sensor
TINY-SUITCASE-1-UK	
TINY-SUITCASE-1-US	
Each suitcase includes a USB key with the software, a flat key, a screwdriver, a charger and has been designed for storing one data logger (including pot magnets and a USB cable).	

TINY-SUITCASE-5-EU	Suitcase for two to five RECOVIB-TINY Sensors
TINY-SUITCASE-5-UK	
TINY-SUITCASE-5-US	
Each suitcase includes a USB key with the software, a flat key, a screwdriver, a charger (simultaneous charging of up to 5 sensors) and has been designed to store up to 5 data loggers (including pot magnets and a USB cable).	

ANDROID APP.

RECOVIB Tiny
Downloadable on your Android devices via Google Play Store free of charge.

COMPUTER SOFTWARE

RECOVIB Suite Computer Software
<ul style="list-style-type: none">• Available free of charge and delivered inside the suitcase• Downloadable via our website• Automatic updates